

**IMPORTANT!**  
READ THROUGH CAREFULLY BEFORE USE.  
KEEP ACCESSIBLE THROUGHOUT THE PRODUCT LIFETIME.



## Heat meter

Compact heat meter Deltamess TKS-WM

---

<b>Safety and warranty</b> .....	<b>3</b>
<b>Radio system</b> .....	<b>3</b>
<b>Safety with lithium batteries</b> .....	<b>4</b>
Safety notes for lithium batteries .....	4
<b>Norms and standards</b> .....	<b>5</b>
Norms and standards .....	5
Temperature sensor.....	5
Connection cable calculator unit - volume meter.....	5
<b>Device elements</b> .....	<b>6</b>
Control elements and interfaces.....	6
Navigating within the levels .....	6
Error messages .....	6
Status displays .....	7
Special operating states .....	7
<b>Display</b> .....	<b>8</b>
Open the fast readout display loop.....	8
Level operating scheme of the standard levels .....	8
Standard levels .....	9
Display level L0 – Current consumption values.....	10
Display level L1 – Annual consumption values.....	11
Display level L2 – Current values.....	12
Display level L3 – Parameters.....	13
Display level L4 – Connections .....	14
<i>Configuration of radio interface</i> .....	14
Display level L4 – Connections .....	15
Display level L5 – Monthly values heat .....	16
Display level L6 – Monthly values cold.....	16
Display level L7 – Monthly values Imp1 .....	17
Display level L8 – Monthly values Imp2 .....	17
Display level L9 – Maximum values .....	18
Error messages .....	19

Please keep the documentation for the entire service life.

### Important information

This product must be installed professionally and in accordance with the prescribed assembly guidelines and may therefore only be installed by qualified and trained experts.

### Intended use

Heat meters are used for the centralised recording of the consumption of heating energy. Heat meters must be used exclusively for this purpose.

### Non-intended use

Any use other than the use described above and any changes made to the device constitute non-intended use, must be queried in writing beforehand and are subject to special approval.

### Warranty and guarantee

Warranty and guarantee claims are only valid if the parts in question have been used in accordance with their intended use and if the technical requirements and any applicable technical regulations have been observed.

### Safety Instructions

Improper handling and excessively forceful tightening of threaded fittings can cause leaks. Observe the maximum torque stated in the manual. The dimensions and thermal loads of seals must be appropriate for their application. You should therefore only use the seals delivered with the device.

### Radio system

---

The radio system rcu4 or the matching radio add-on modules are not compatible with this heat meter.



The installed meter is a pressurized component.  
There is a risk of persons suffering scolds from hot water.

### Safety notes for lithium batteries

---



Certain heat meter components can be equipped with a lithium battery.

**This type of battery is classified as dangerous goods.**

VALID TRANSPORT REGULATIONS ARE TO BE ADHERED TO IN EACH CASE! Inspection documents for the batteries used are available on request.

#### Handling of lithium batteries

- Store protected from dampness and moisture
- Do not heat to above 100 °C or throw into fire
- Do not short-circuit
- Do not open or damage
- Do not charge
- Keep out of reach of children

In the event of an accident, the following points must be heeded:

#### In case of a leak:

- Cover with sodium carbonate or an equivalent crystal soda
- Make gases and vapours precipitate by spraying with water
- Make sure of sufficient ventilation
- Avoid any direct contact

#### In the event of injuries:

- If interior components of the dry element should come into contact with the eyes, rinse thoroughly with water for 15 minutes.
- In the event of contact with the skin, wash with plenty of water and take off soiled clothing.
- Move away from the accident spot following inhalation.
- Always consult a doctor.

#### In the event of fire:

- Use a Lith-X or Class-D fire extinguisher.
- NEVER USE WATER FOR EXTINGUISHING PURPOSES
- Do not use CO<sub>2</sub>, halogen fire extinguishers with dry substances or foam extinguishers.
- Move away from the accident spot following inhalation and ventilate the area.
- Always consult a doctor.

## Norms and standards

Conformity	see EU Declaration of Conformity (enclosed)
------------	---

### Electromagnetic compatibility

Interference resistance	EN 61000-6-2
Emitted interference	EN 61000-6-3

### Protection rating

IP protection rating	IP65 according to EN 60529
----------------------	----------------------------

### Heat meter

European Measuring Instruments Directive (MID)	2004/22/EC and 2014/32/EU
EC-type examination certificate	DE-12-MI004-PTB009
Heat meter	CEN EN1434
Quality of heat medium	in accordance with VDI guideline 2035 in accordance with AGFW-standard 510

### Influencing quantities

Electromagnetic class	E1
Mechanical class	M1
Environment class	A
Precision class	3

### Temperature sensor

Sensor diameter and cable lengths		
Temperature sensor supply flow (red)	5.2 mm	1.5 m (opt. 3 m)
Temperature sensor return flow (blue)	5.2 mm	0.8 m

### Connection cable calculator unit - volume meter

Cable length (calculator unit wall installation)	30 cm
--	-------

### Control elements and interfaces

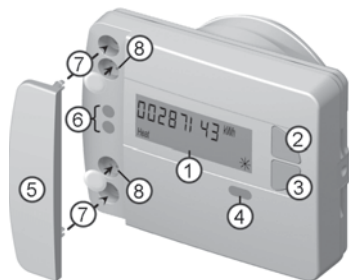

- (1) LC display  
The display is off as standard (sleep mode). The display can be activated by pressing a key.
- (2) Key <H> (horizontal)
- (3) Key <V> (vertical)
- (4) IrDA interface
- (5) Interface cover
- (6) Module interface
- (7) Attachment holes for external optical modules
- (8) User protection and slots for external cable connections

### Navigating within the levels

1. To open the display loop or level operating scheme



Press the <H> or <V> key **briefly** to open the fast readout display loop.

Press the <H> or <V> key **longer than 3 seconds** to open the level operating scheme.

2. To change from any position on one level to the next level



Press the <H> key

3. To change to the next display within one level



Press the <V> key

### Error messages





If a serious error occurs with the device, the error code and error date are displayed before the meter status.

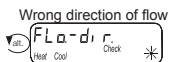





If the incorrect direction of flow is established, an error message appears on the display as shown.



## Status displays

Display	Description
	<p>The data displayed apply for:</p> <ul style="list-style-type: none"> <li>Heat</li> <li>Cool = Cold</li> <li>Imp1 = Impulse input 1</li> <li>Imp2 = Impulse input 2</li> </ul>
	<ul style="list-style-type: none"> <li>(empty) = Displayed value is the current value</li> <li>M (Memory) = Value on a monthly or due date</li> </ul>
	<p>Displayed value is a date value:</p> <ul style="list-style-type: none"> <li>Day = Current date</li> <li>M-Day = Date applies for a saved annual or monthly value</li> </ul>
	<p>Displayed value is a checksum:</p> <ul style="list-style-type: none"> <li>Check = Checksum refers to the current consumption value</li> <li>M-Check = Checksum is valid for a saved annual or monthly value</li> </ul>

## Special operating states

Display	Description	Measures/Notes
	<ul style="list-style-type: none"> <li>Communication credit of the module interface or IrDA exceeded</li> </ul>	<ul style="list-style-type: none"> <li>Is eliminated after the credit period (module = current day; IrDA = current month) has passed</li> </ul>
	<ul style="list-style-type: none"> <li>Operating time expired</li> </ul>	<ul style="list-style-type: none"> <li>Device must be replaced</li> </ul>
	<ul style="list-style-type: none"> <li>Wrong direction of flow</li> </ul>	<ul style="list-style-type: none"> <li>Check installation (note arrow on flow sensor)</li> <li>Check piping</li> <li>Check recirculating pumps and thermostats for correct function</li> </ul>
	<ul style="list-style-type: none"> <li>Temperature sensors have been mixed up or fitted incorrectly</li> </ul>	<ul style="list-style-type: none"> <li>Check whether flow sensor has been fitted in the right strand or</li> <li>check type of installation of temperature sensor</li> </ul>

## Open the fast readout display loop

The display is always off as standard (sleep mode ☾).



Press the < H > key **briefly** or



the < V > key **briefly**

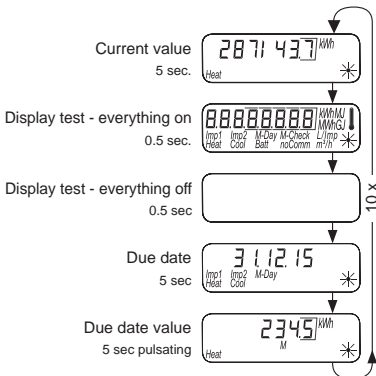

The fast readout display starts with the current consumption value.

After 10 repetitions, the display automatically changes back to sleep mode.

You can change to the level operating scheme at any time. To do so, press the < H > or < V > key for longer than 3 seconds.

Error messages are displayed with the error number and the error date for 5 seconds before the "Current value" display is shown.

## Level operating scheme of the standard levels



Press the < H > key or



the < V > key for **longer than 3 seconds**.

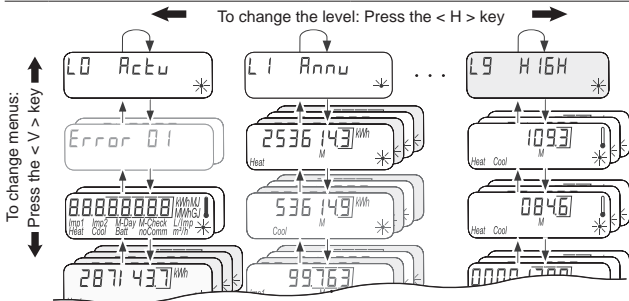



## Standard levels

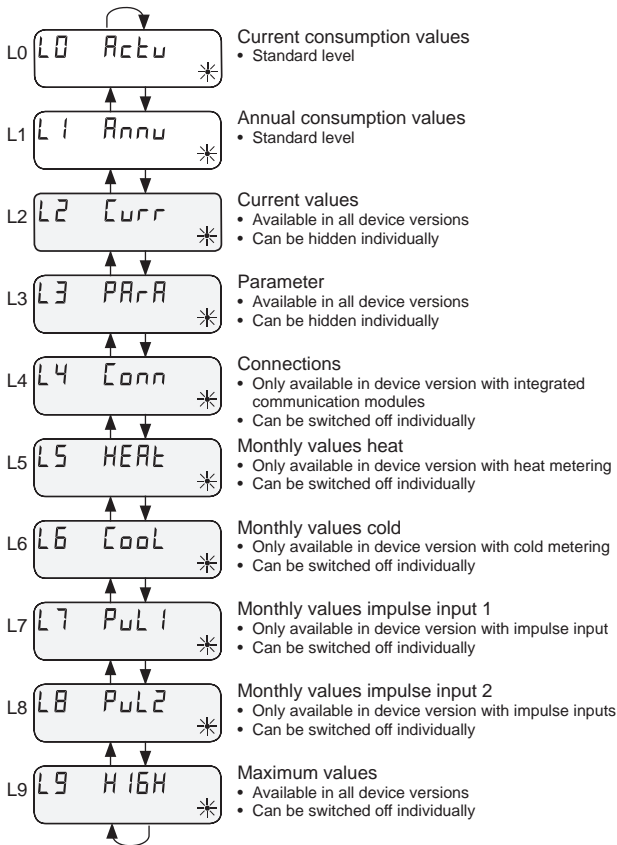

**Display level L0 – Current consumption values**

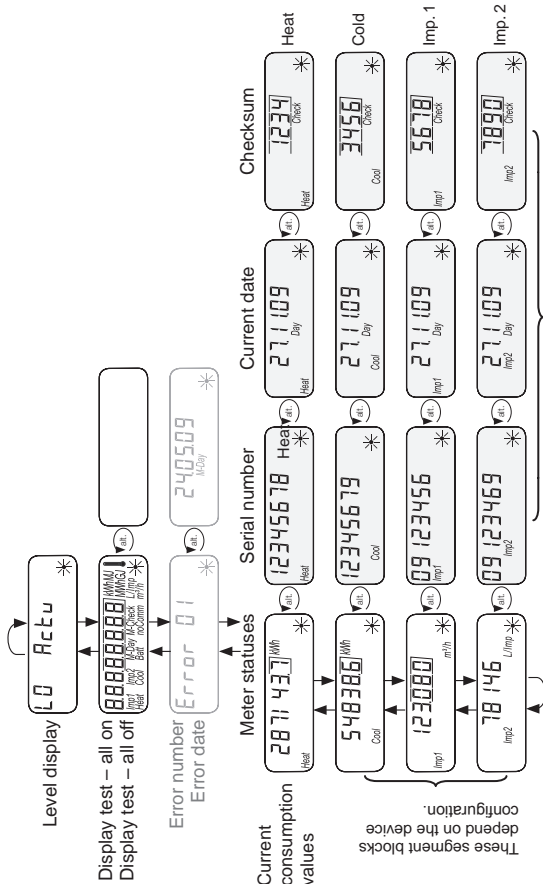

## Display level L1 – Annual consumption values

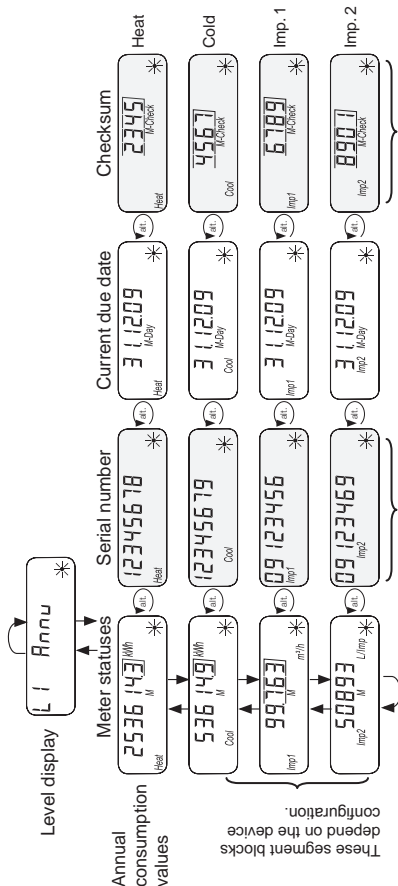

## Display level L2 – Current values

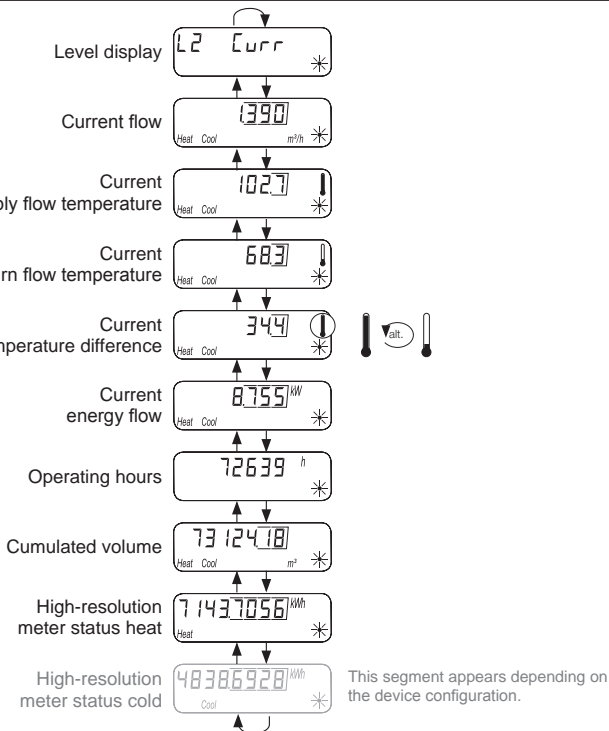

## Display level L3 – Parameters

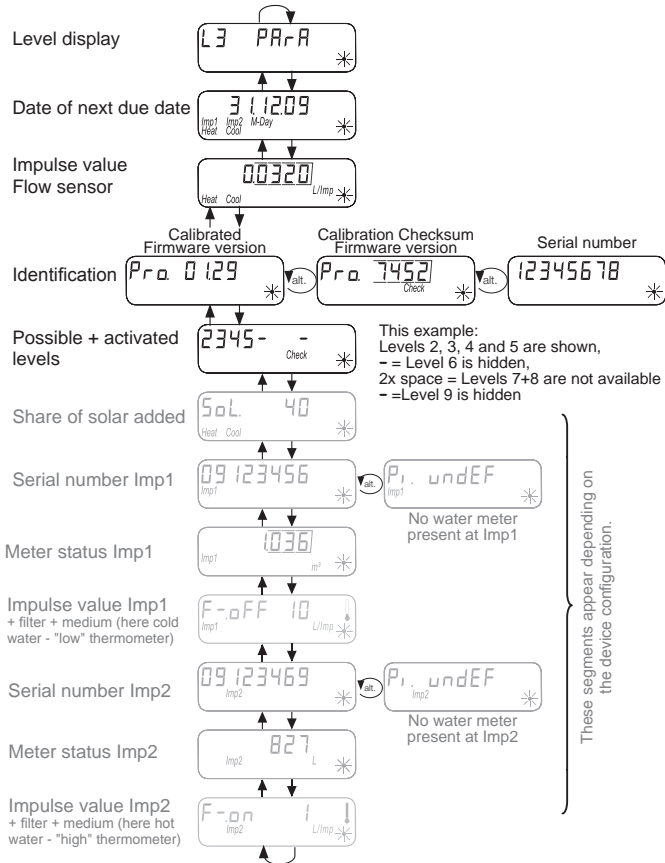

## Display level L4 – Connections

These segment blocks appear depending on the device configuration.

### Configuration of radio interface

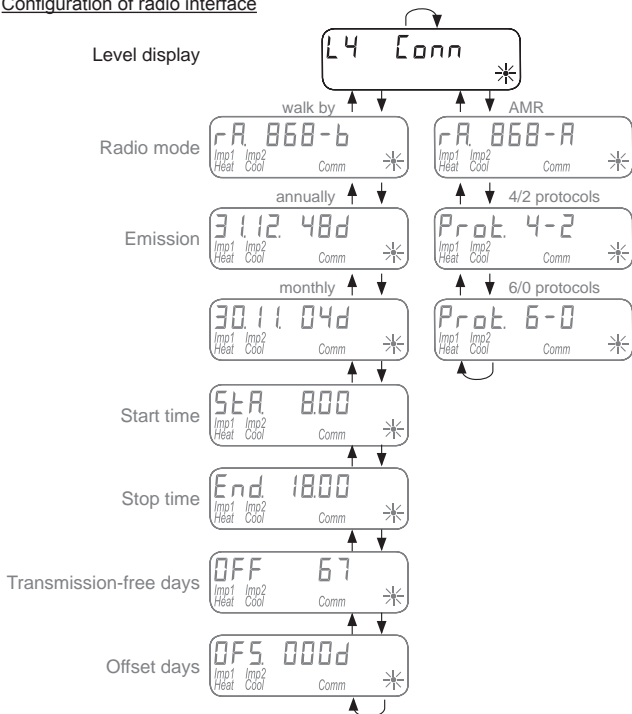

## Display level L4 – Connections

These segment blocks appear depending on the device configuration.

### Configuration of M-Bus interface

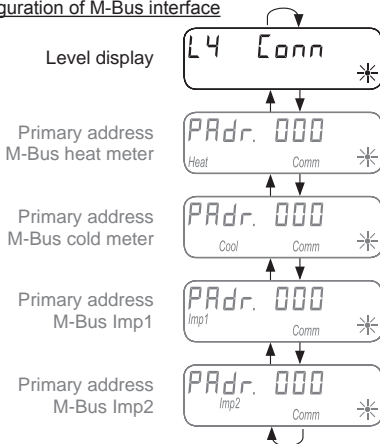

### Configuration of impulse output

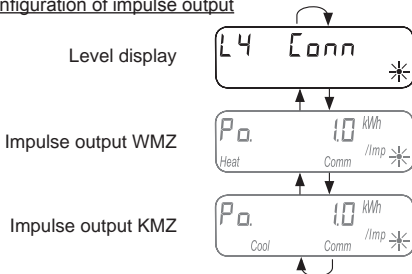

**Display level L5 – Monthly values heat**

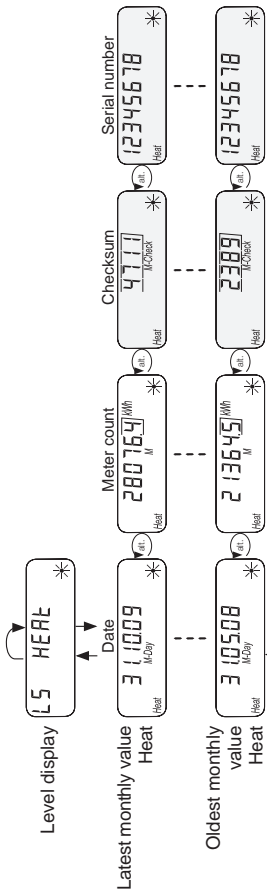

The displays coloured grey are optional or can be added and switched off as required.

**Display level L6 – Monthly values cold**

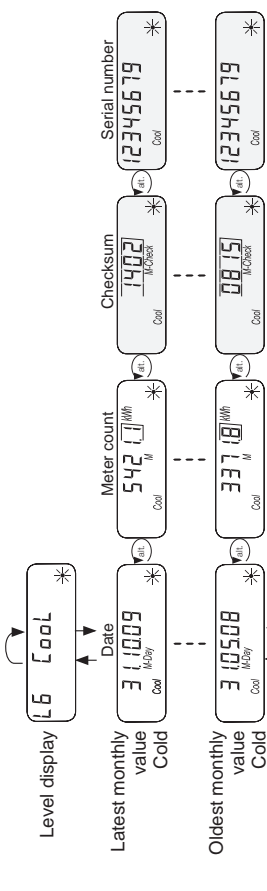

The displays coloured grey are optional or can be added and switched off as required.



### Display level L7 – Monthly values Imp1

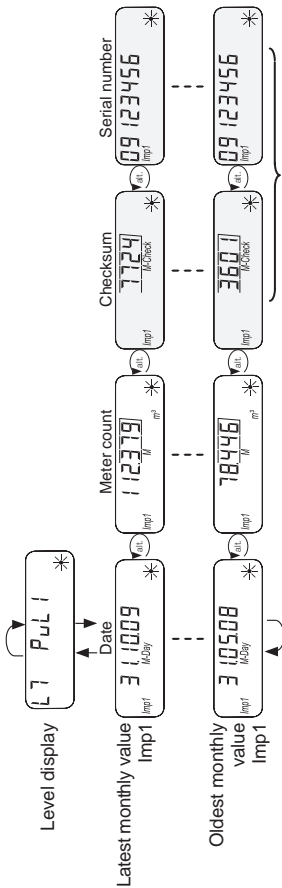

### Display level L8 – Monthly values Imp2

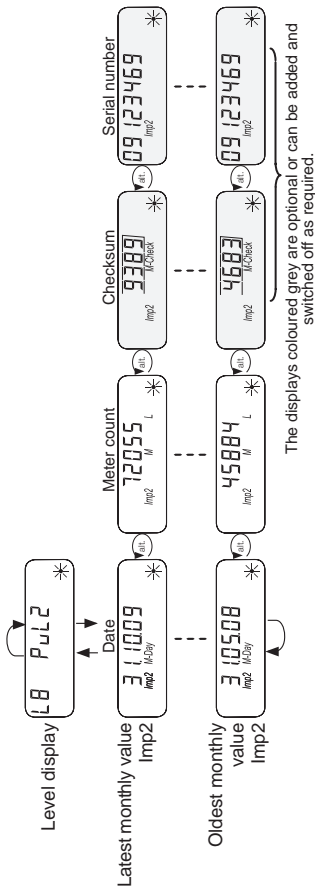

## Display level L9 – Maximum values

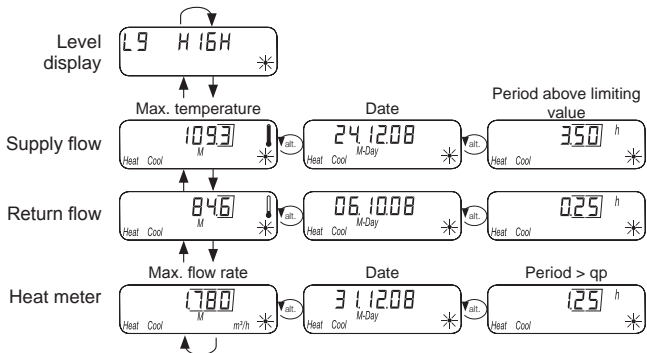

## Error messages

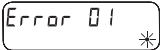
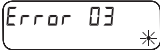
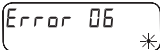
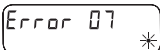
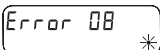
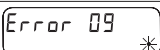
Error display	Error description	Measures/Notes
 Error 01 *	<ul style="list-style-type: none"> <li>Hardware error or damaged firmware</li> </ul>	<ul style="list-style-type: none"> <li>Check flow sensor, connection cable and calculator unit for external damage</li> <li>Device must be replaced</li> </ul>
 Error 03 *	<ul style="list-style-type: none"> <li>Add-on module has been paired with another meter before</li> </ul>	<ul style="list-style-type: none"> <li>The module has the measuring data of another heat meter</li> <li>Save data, since these are overwritten after a short time</li> <li>Press any key to delete the display</li> </ul>
 Error 06 *	<ul style="list-style-type: none"> <li>Supply flow sensor broken</li> </ul>	<ul style="list-style-type: none"> <li>Check temperature sensor and pipes for mechanical damage</li> <li>Device must be replaced</li> </ul>
 Error 07 *	<ul style="list-style-type: none"> <li>Short circuit supply flow sensor</li> </ul>	<ul style="list-style-type: none"> <li>Check temperature sensor and pipes for mechanical damage</li> <li>Device must be replaced</li> </ul>
 Error 08 *	<ul style="list-style-type: none"> <li>Return flow sensor broken</li> </ul>	<ul style="list-style-type: none"> <li>Check temperature sensor and pipes for mechanical damage</li> <li>Device must be replaced</li> </ul>
 Error 09 *	<ul style="list-style-type: none"> <li>Short circuit return flow sensor</li> </ul>	<ul style="list-style-type: none"> <li>Check temperature sensor and pipes for mechanical damage</li> <li>Device must be replaced</li> </ul>

---

**DELTAMESS DWWF GmbH**  
Sebenter Weg 42  
D-23758 Oldenburg in Holstein  
Tel. +49 (0) 43 61/ 51 14-0  
Fax +49 (0) 43 61/ 51 14-88

[www.deltamess.de](http://www.deltamess.de)

Compact heat meter Deltamess  
Type: TKS-WM  
Document no.: 30204-05  
Source DM\_Bedienungs-Anleitung  
Issue date: 1.04.2016  
Issue status: 04.16  
Print no.: FOM-DMHE-EN0-DSPLY  
V 4.0

---